

**dimara** PUERTAS [www.dimara.es](http://www.dimara.es)



dimara #

ABRIMOS TUS SENTIDOS



**dimara** PUERTAS  
ABRIMOS TUS SENTIDOS



**ABRIMOS TUS SENTIDOS**

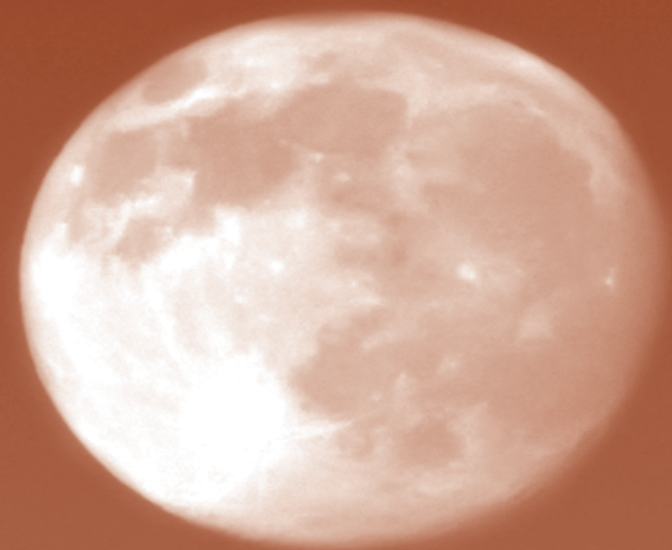

catálogo editado: PUERTAS DIMARA, S.A.  
fotografía: MAESTRE  
diseño e impresión: PENTAGRAF IMPRESORES, S.L.



dimara

ABRIMOS TUS SENTIDOS

CATÁLOGO GENERAL

# SOLIDOS!

Imagínate un mundo donde las puertas siempre están abiertas!

En DIMARA, moderna empresa industrial, basamos nuestra filosofía en la devoción por el trabajo, con un único fin: la satisfacción de nuestros clientes. Este es el hilo conductor de toda nuestra actividad: la pasión por las puertas. Aquí ha nacido nuestro estilo, lo que marca la diferencia. Calidad de los materiales, innovación tecnológica, belleza de las formas y esmerada atención a los detalles. Este es el estilo DIMARA. Nosotros somos lo que hacemos; sólidos como nuestras puertas. Porque amamos nuestro trabajo y hacerlo bien. Desde siempre.

*In DIMARA, modern industrial company, our philosophy is based in our devotion for good work with a unique goal: to achieve our customer's satisfaction. This is the connecting thread of our entire activity: the passion for doors. Here arise our style, what makes the difference: quality of materials, technological innovation, beauty of shapes and carefully attention to details. This is DIMARA style. We are what we make; as strong as our doors. Because we love our work and to do it right. From the beginning.*



dimara

## ÍNDICE / INDEX

SERIE VIVA METAL / <i>SERIE VIVA METAL</i>	04
SERIE VIVA MADERA / <i>SERIE VIVA MADERA</i>	10
SERIE DUAL / <i>SERIE DUAL</i>	28
SERIE NATURA / <i>SERIE NATURA</i>	46
SERIE PRELACADA / <i>SERIE PRELACADA</i>	56
SERIE MELAMINA / <i>SERIE MELAMINE</i>	60
ARMARIOS / <i>CABINETS</i>	66
CASONETO / <i>CASONETO</i>	70
PUERTAS ACORAZADAS / <i>ARMORED DOOR</i>	72
CARACTERÍSTICAS TÉCNICAS <i>TECHNICAL CHARACTERISTICS</i>	74
MADERAS DISPONIBLES <i>VENEERS CHART</i>	76



• VMA METAL wengué / wenge

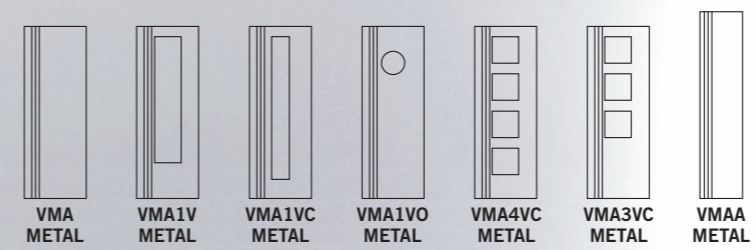

# serie VIVAmetal

La serie VIVA METAL ofrece originales diseños que realzan la singularidad de cada entorno.

*VIVA METAL Collection offers original designs which enhance the singularity of every environment.*

• **V1V METAL** ébano / *ebony*

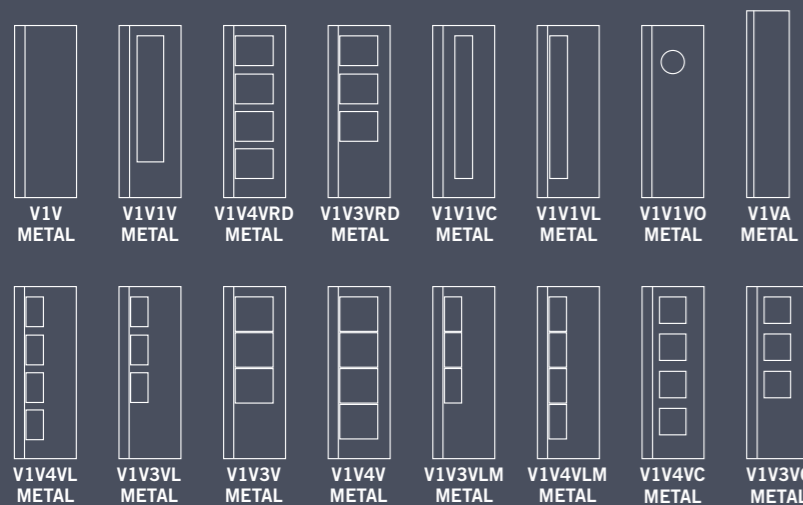
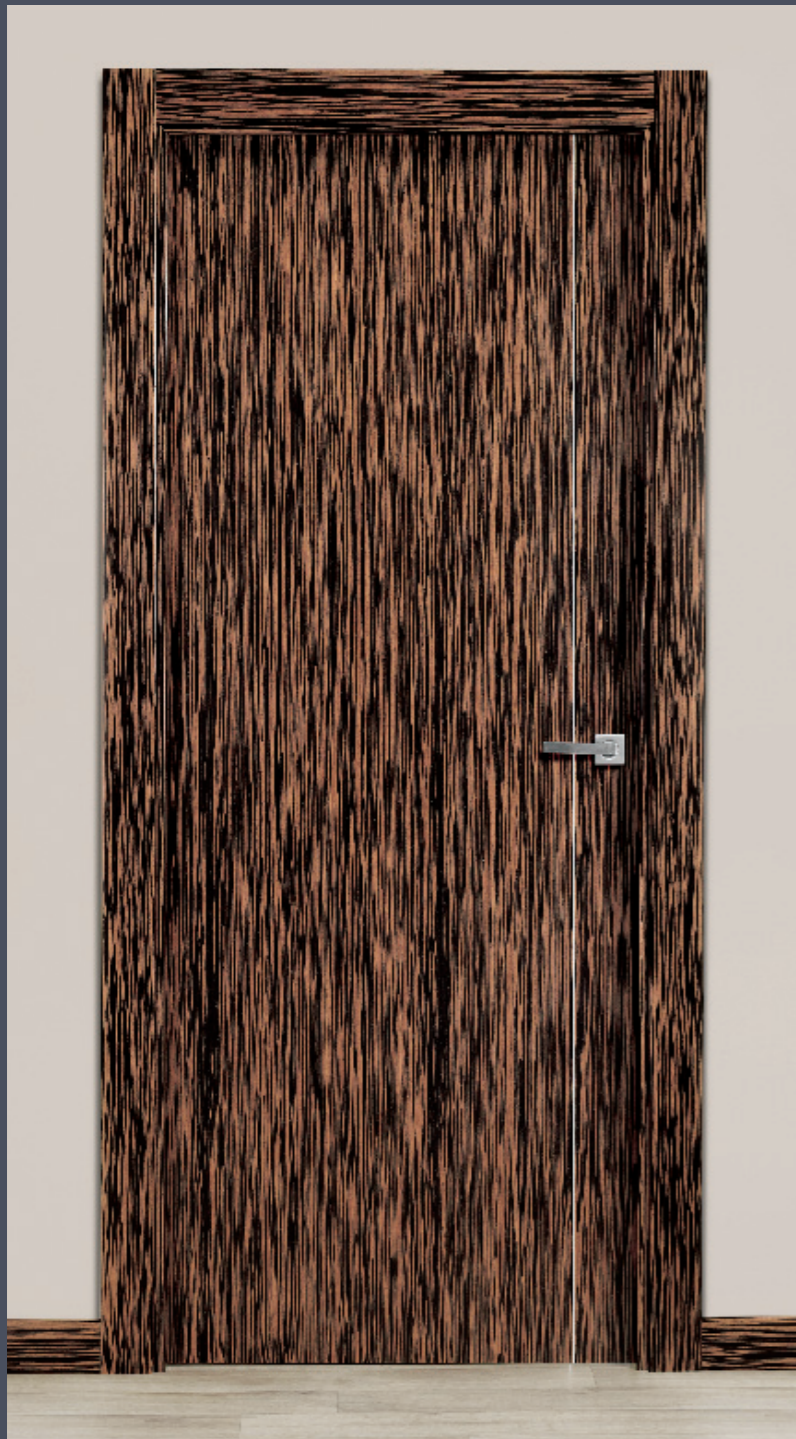

• **VCS METAL** sapelly dibujo / *crown sapelly*

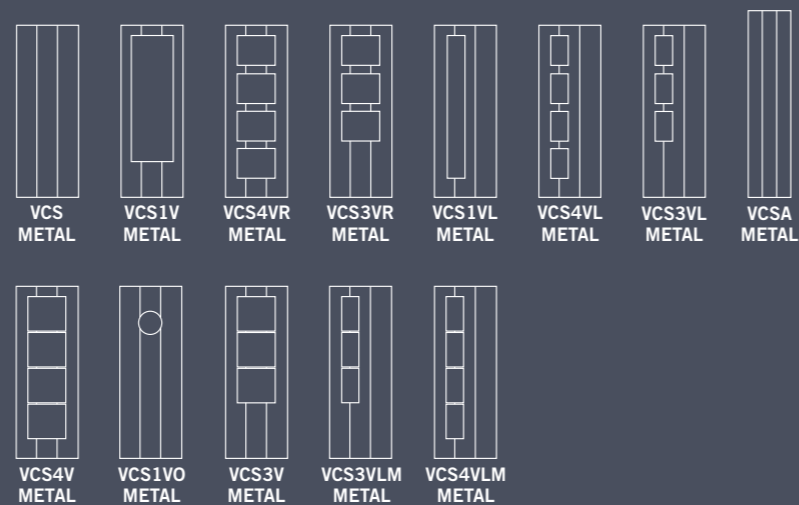
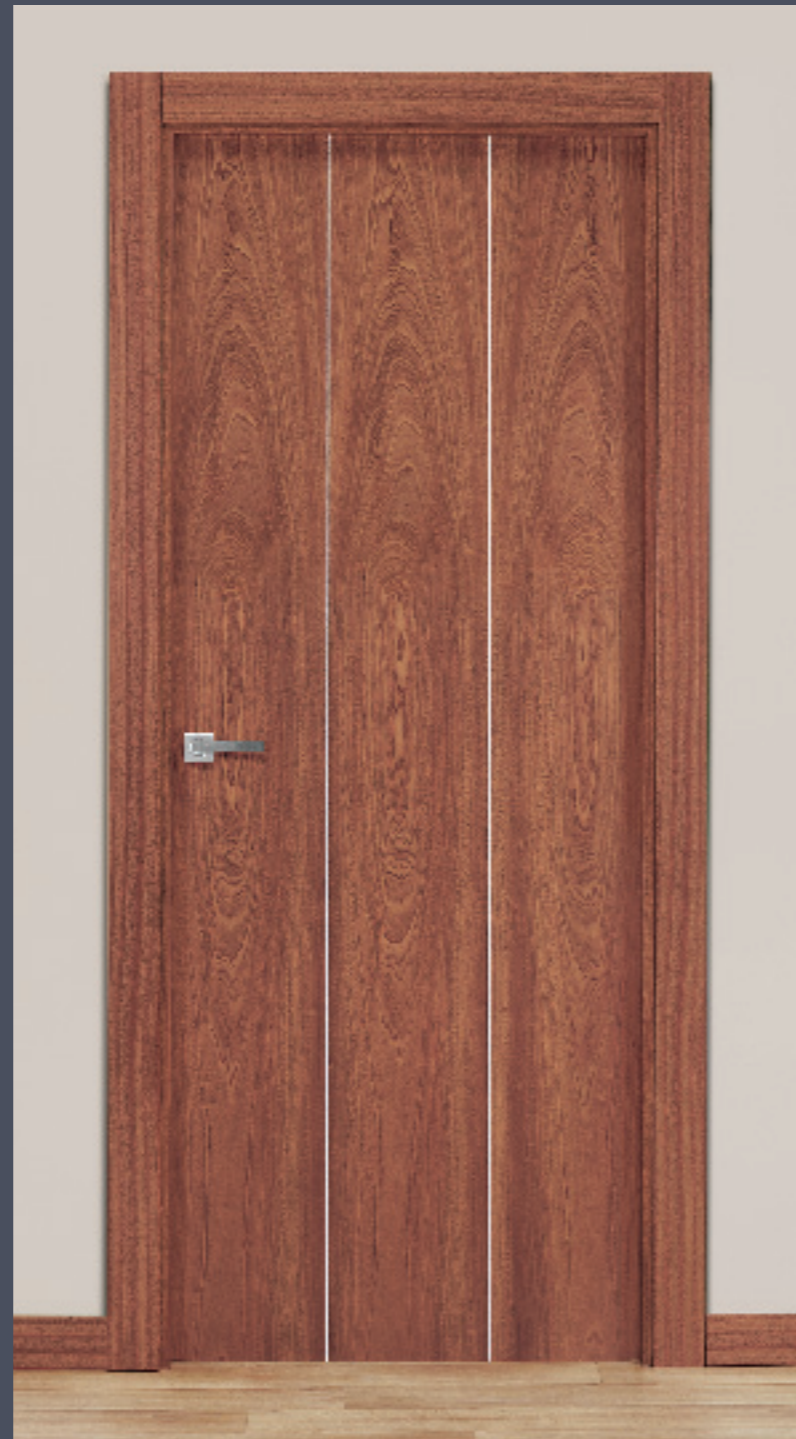

• **V2V METAL** etimoe / *etimoe*

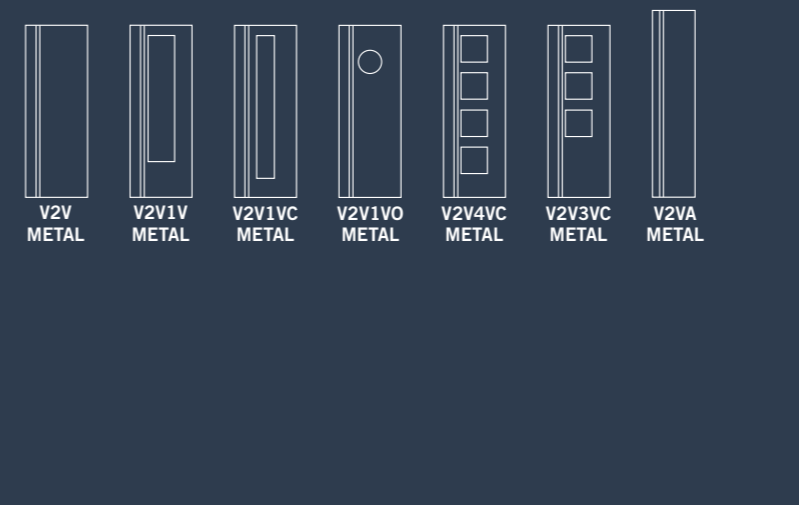
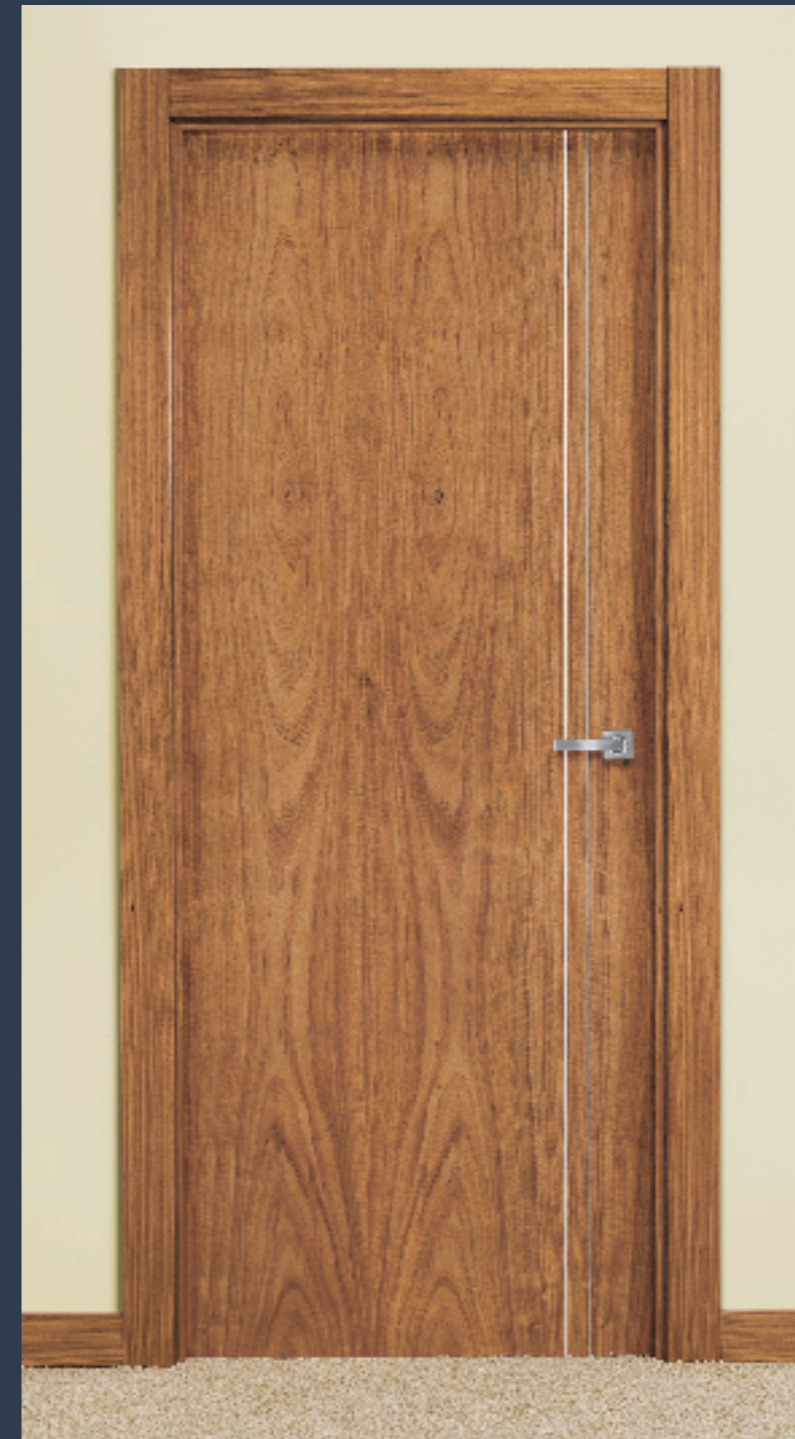

• **VV METAL** wengué / *wenge*

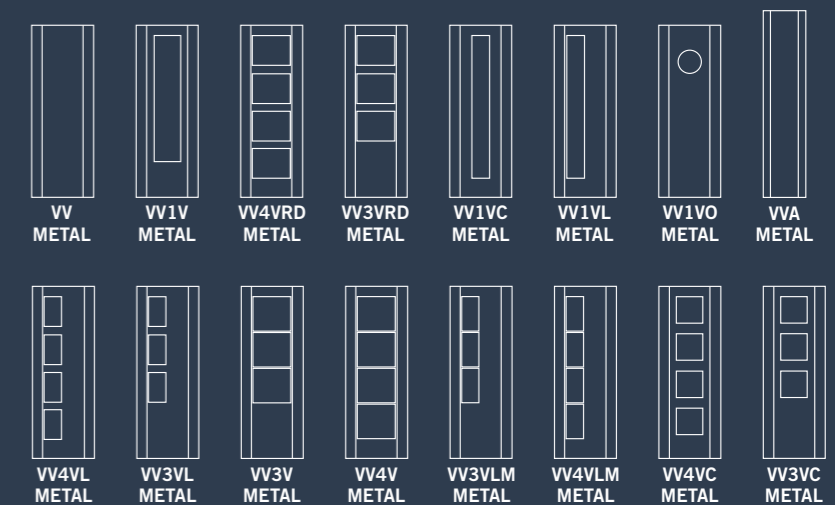
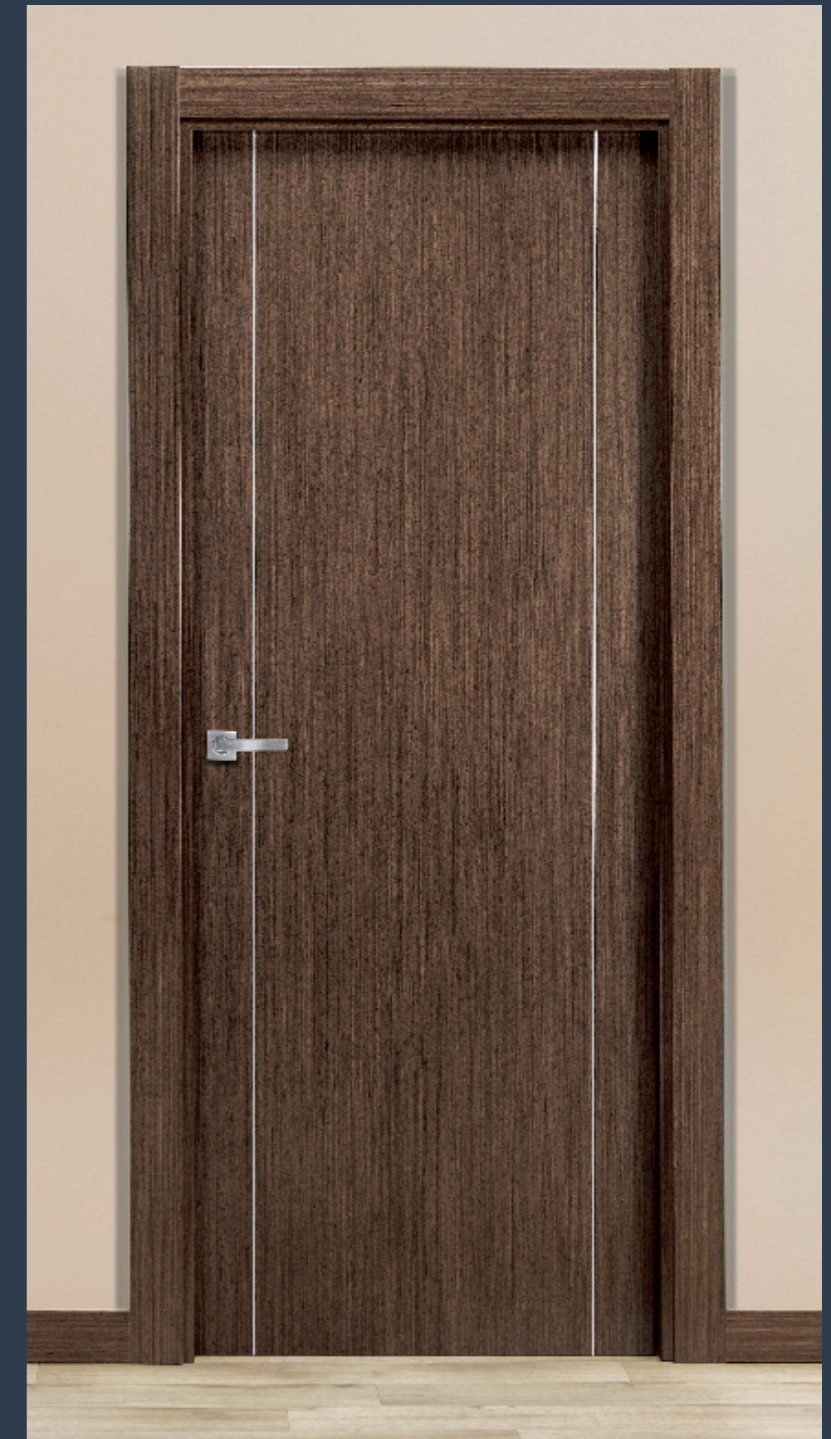

• **VL METAL** nogal / walnut

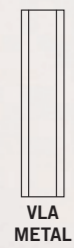
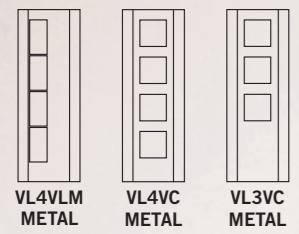
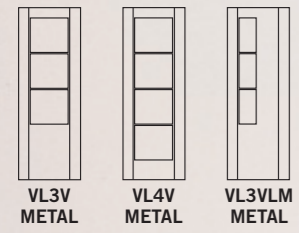
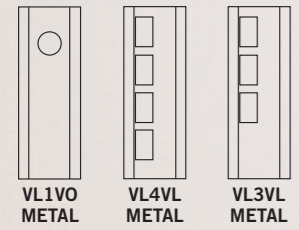
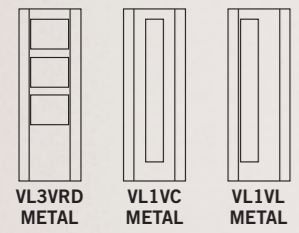
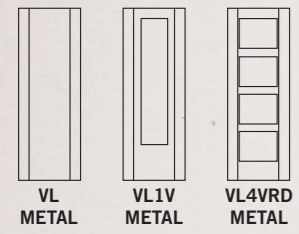

• **V4H METAL** cedro / cedar

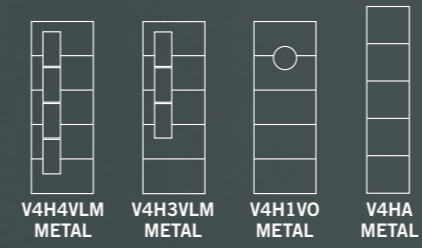
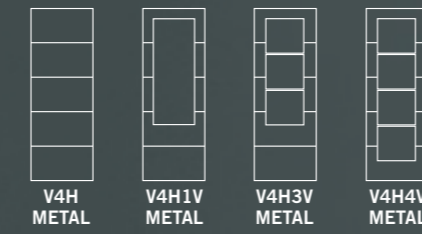

A modern interior scene featuring a wooden door, a red sofa, and a window. The door is made of cherry wood and has a silver handle. The sofa is red and has a modern design. The window is on the right side of the image and shows a view of a green landscape. There are two pendant lights hanging from the ceiling.

• V5V MADERA cerezo / cherry

serie **VIVA** maderas

En la serie VIVA presentamos un amplio abanico de modelos, prestando especial interés a cada detalle para conseguir los mejores acabados.

*In VIVA Collection we present a wide range of models, paying special attention to every detail to achieve the best finish*



• **V5V MADERA** cerezo / cherry



• **V5V1VC MADERA** cerezo / cherry

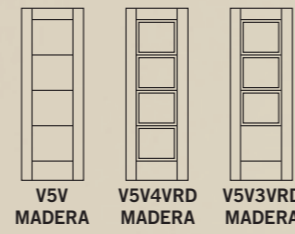

V5V  
MADERA

V5V4VRD  
MADERA

V5V3VRD  
MADERA

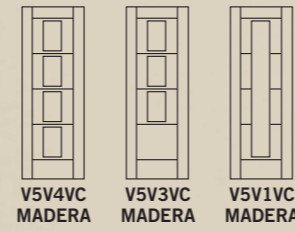

V5V4VC  
MADERA

V5V3VC  
MADERA

V5V1VC  
MADERA



V5VA  
MADERA



• **V4V MADERA** cerezo / cherry

• **V4V4VC MADERA** cerezo / cherry

• **V6V MADERA** haya vaporizada / steamed beech

• **V6V5VC MADERA** haya vaporizada / steamed beech

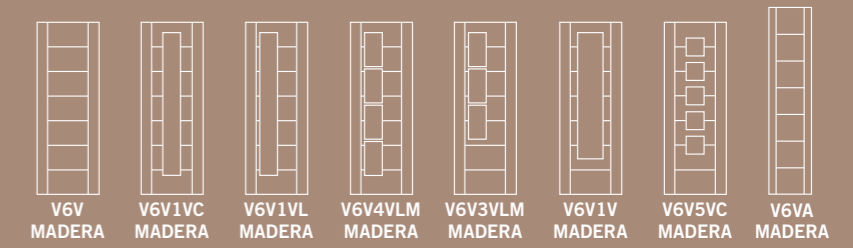
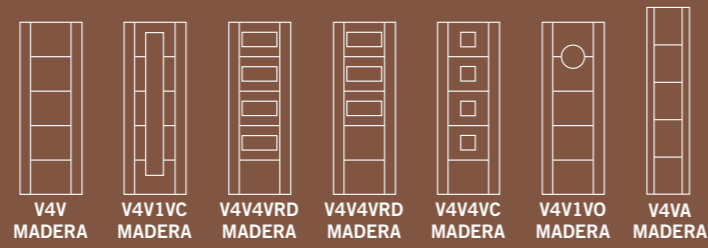

• **VF MADERA** nogal / walnut



• **VF4VLM MADERA** nogal / walnut

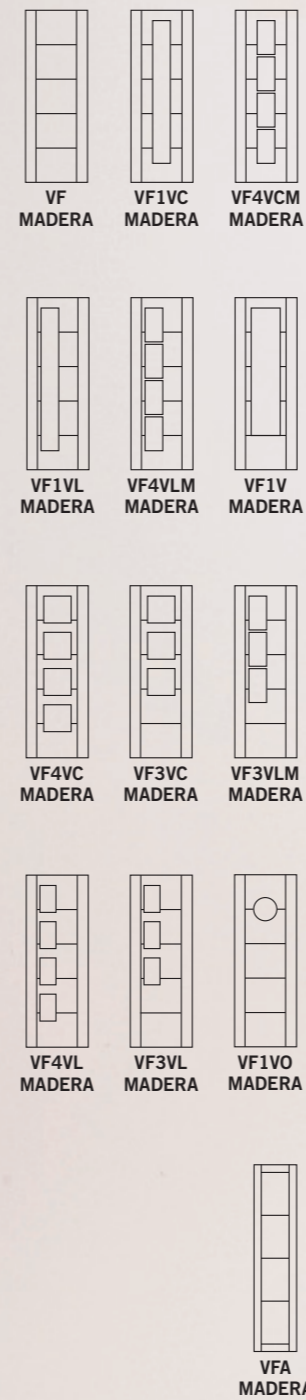

• **VL MADERA** haya vaporizada / *steamed beech*

• **VL3VC MADERA** haya vaporizada / *steamed beech*

• **VV MADERA** iroko / *iroko*

• **VV1V MADERA** iroko / *iroko*

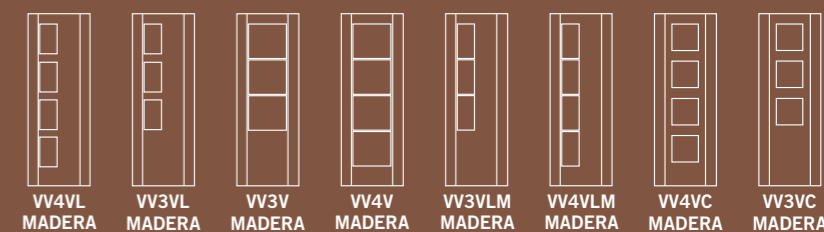
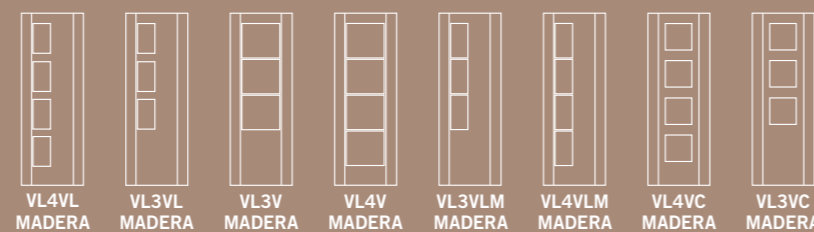

• **VD MADERA** maple / maple



• **VD3V MADERA** maple / maple

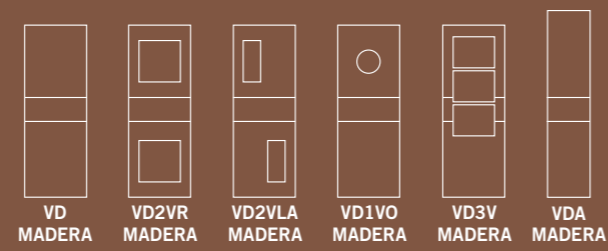

• **VE MADERA** roble / oak



• **VE1VL MADERA** roble / oak

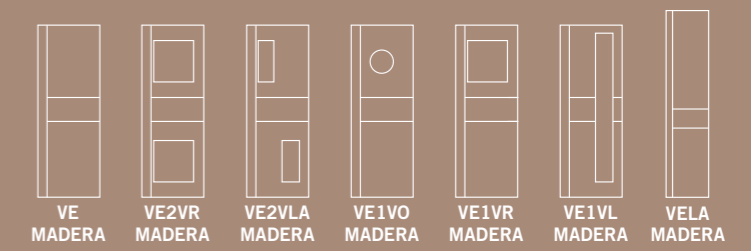

• **V3H MADERA** roble / oak



• **V3H3V MADERA** roble / oak



• **V4H MADERA** haya vaporizada / steamed beech



• **V4H3V MADERA** haya vaporizada / steamed beech

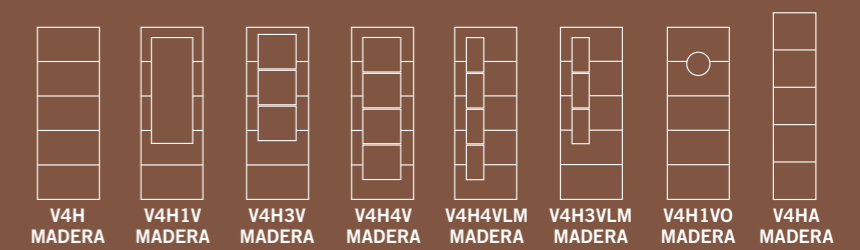
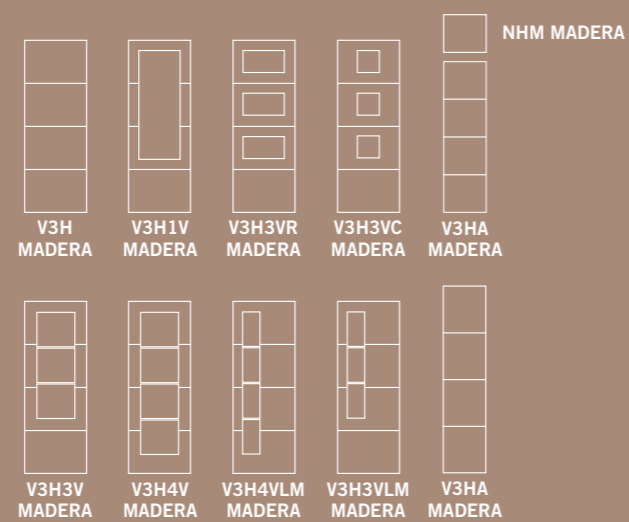

• **V6H MADERA** mukali / mukaly

• **V6H5VC MADERA** mukali / mukaly

• **V5H MADERA** cedro / cedar

• **V5H3VC MADERA** cedro / cedar

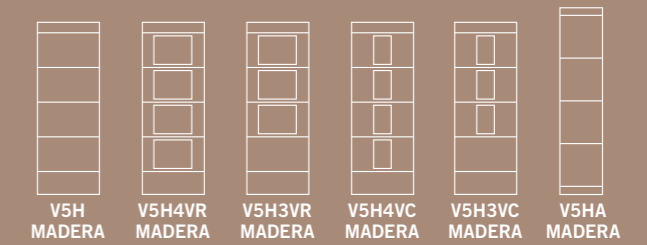

• **VX MADERA** cedro / cedar



• **VX3VLM MADERA** cedro / cedar



• **V1V MADERA** cerezo / cherry

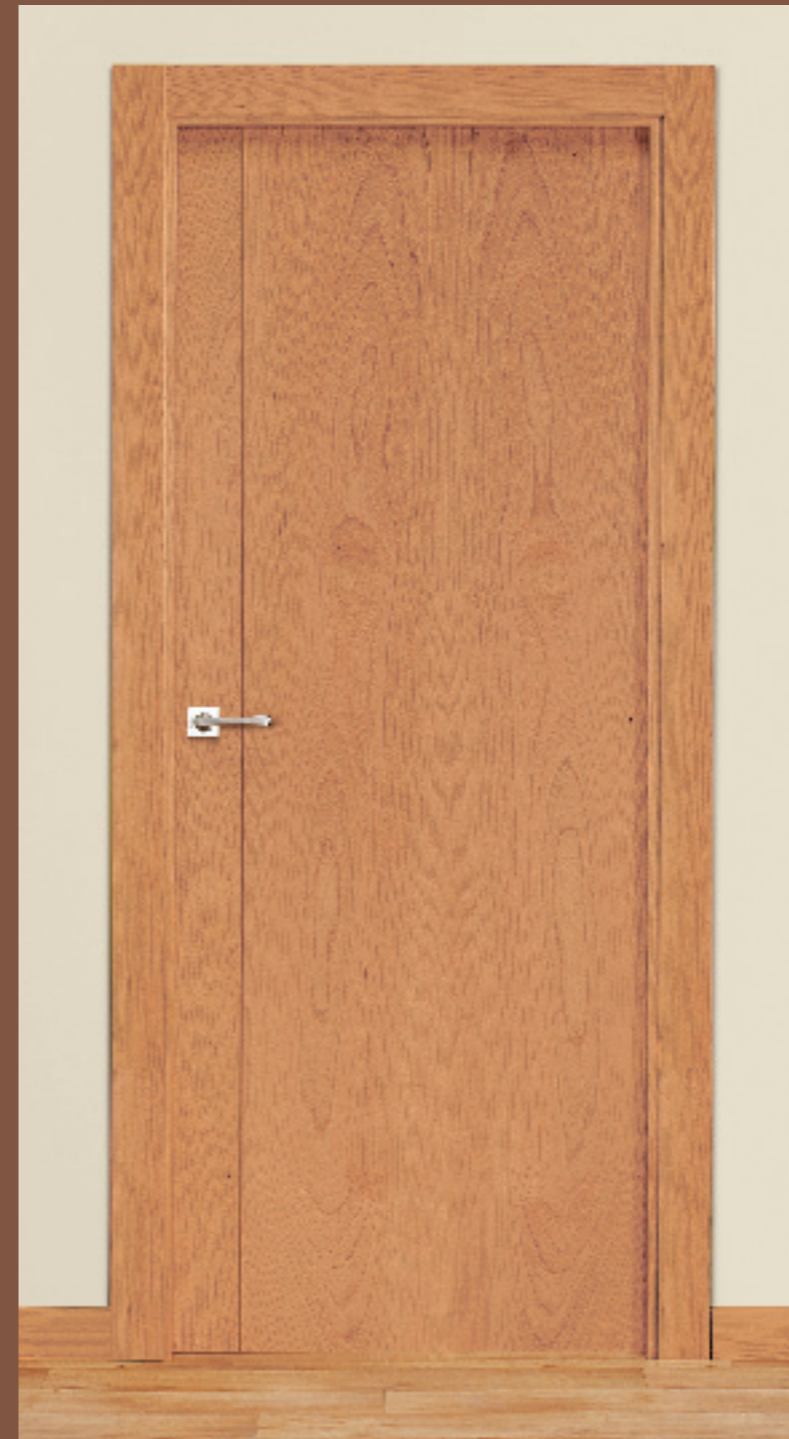

• **V1V4VL MADERA** cerezo / cherry

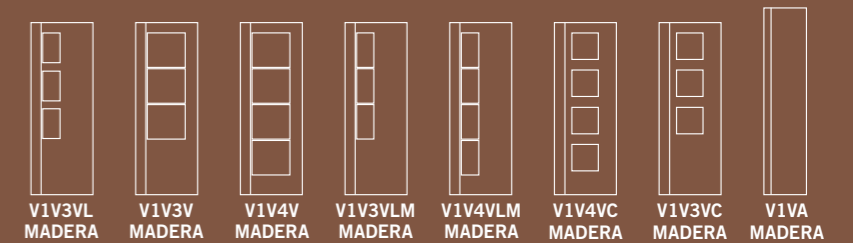
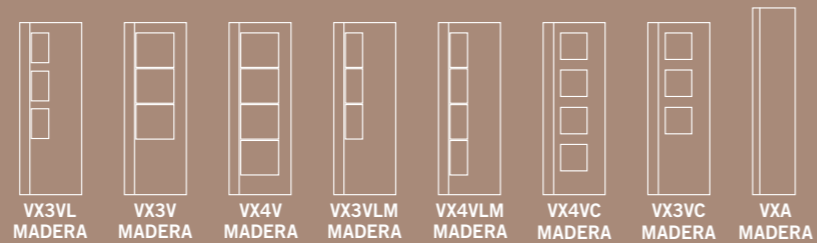





- DA nogal / walnut  
greca combinada /  
combined inlay

- etimoe / *etimoe*
- haya blanca / *white beech*
- haya blanca-etimoe-haya blanca /  
*white beech-etimoe-white beech*
- haya vaporizada / *steamed beech*
- negro / *black*
- maple / *maple*
- roble / *oak*
- nogal / *walnut*
- negro-haya blanca-negro /  
*black-white beech-black*
- haya blanca-negro-haya blanca /  
*white beech-black-white beech*

# serie DUAL

DIMARA presenta la serie DUAL, con contrastes en sus líneas. Modelos que pueden personalizarse combinando las diferentes maderas, consiguiendo así una puerta acorde a cada ambiente.

*DIMARA presents DUAL Collection, full of contrast in its lines. Models which can be personalized combining different veneers, achieving a door according to every environment.*

- **DA4VC** nogal / walnut  
greca combinada / combined inlay

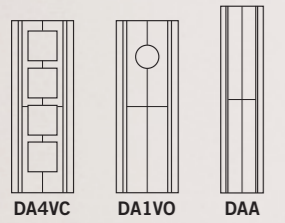
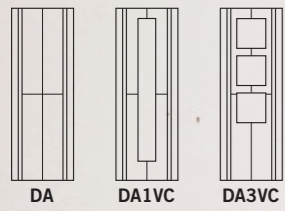

- **DA** nogal / walnut  
greca combinada / combined inlay



- **DX** mukali / mukaly  
greca negra / black inlay

- **DX3VC** mukali / mukaly  
greca negra / black inlay

- **DXV** roble blanco / white oak  
greca nogal / walnut inlay

- **DXV3VL** roble blanco / white oak  
greca nogal / walnut inlay

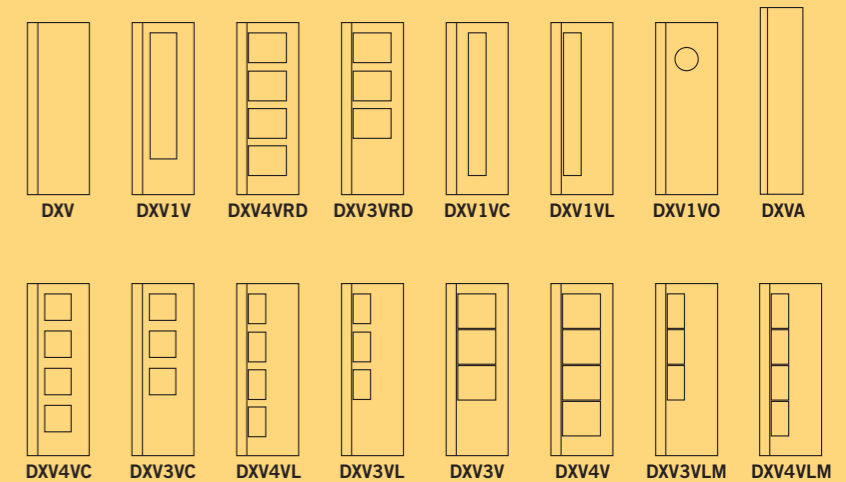
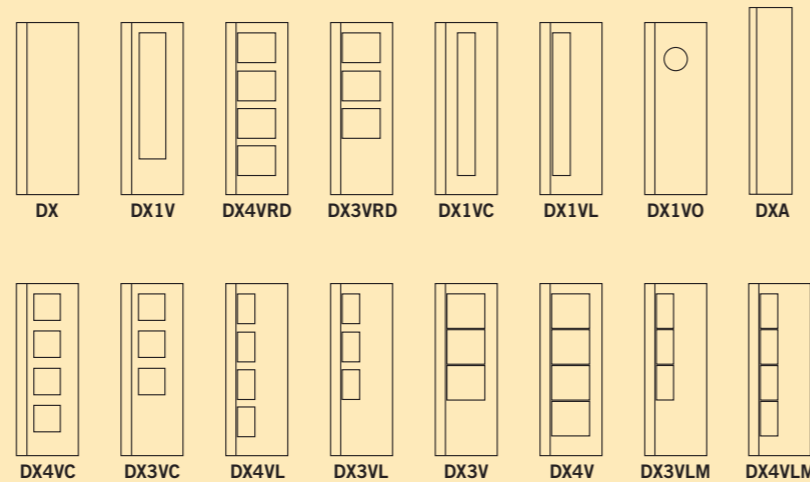

- **DDL** ébano / *ebony*  
greca combinada / *combined inlay*



- **DDL2VLA** ébano / *ebony*  
greca combinada / *combined inlay*

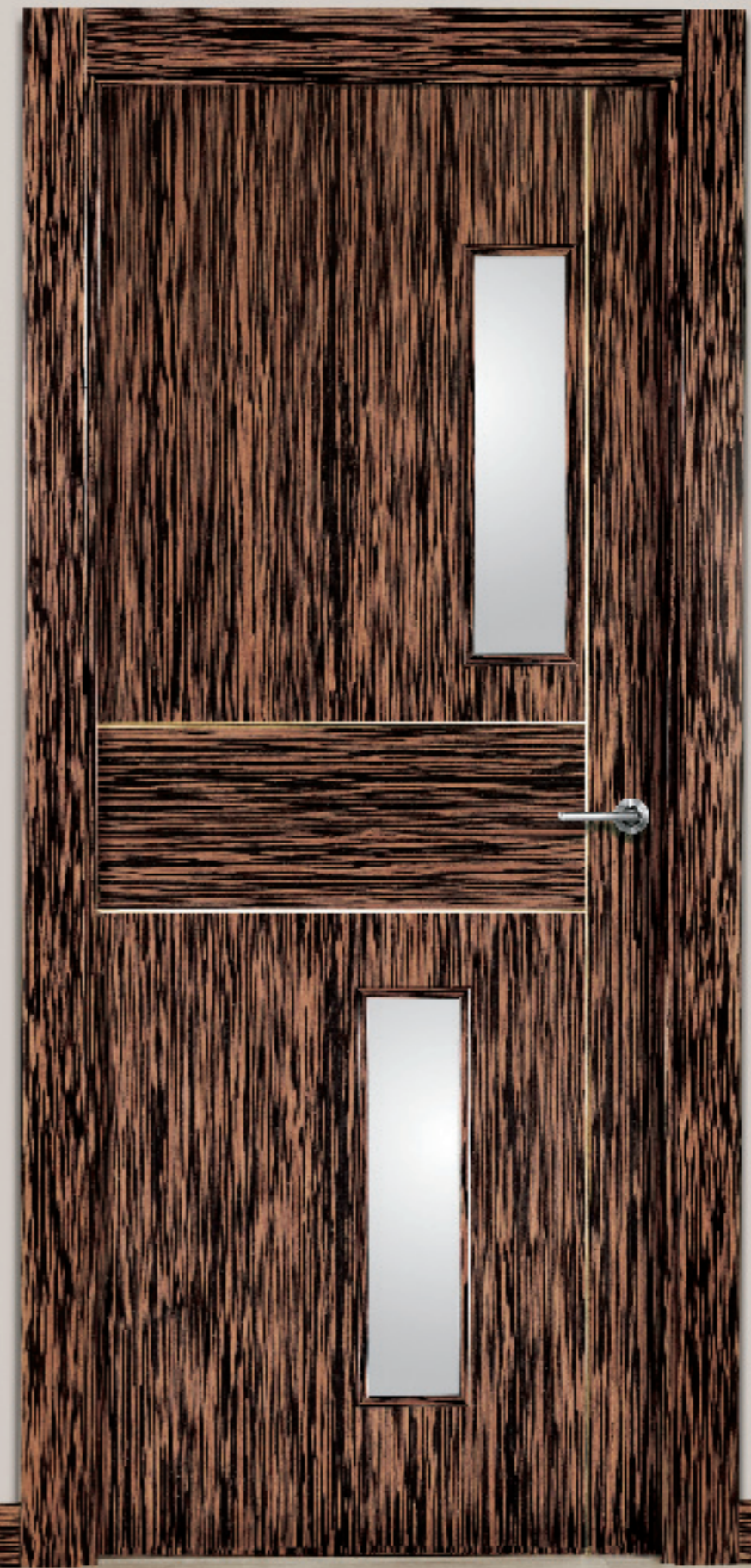
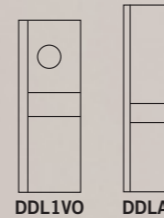
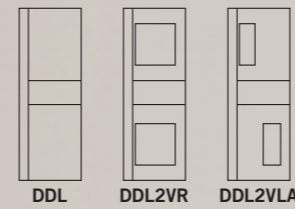

- **D4D** sapelly / *sapelly*  
greca haya blanca / *white beech inlay*

- **D4D1VC** sapelly / *sapelly*  
greca haya blanca / *white beech inlay*

- **DC3G** haya vaporizada / *steamed beech*  
greca etimoe / *etimoe inlay*

- **DC3G3V** haya vaporizada / *steamed beech*  
greca etimoe / *etimoe inlay*

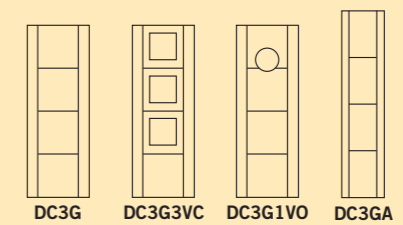
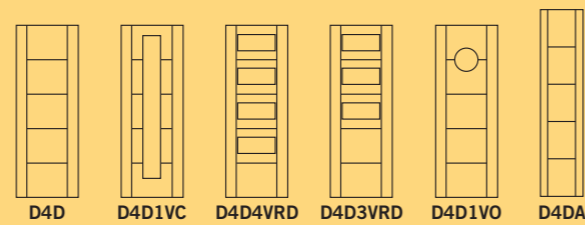

- **DV1V** sapelly dibujo / crown sapelly greca haya blanca / white beech inlay

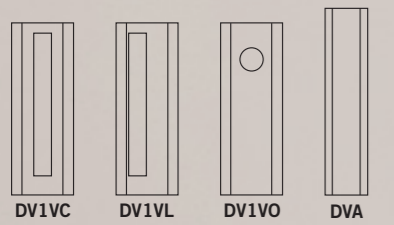
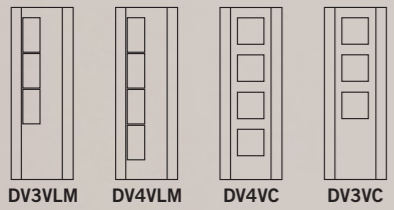
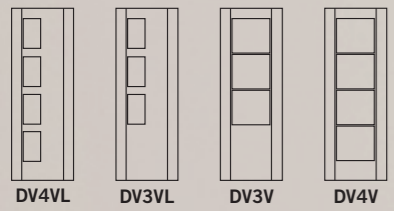
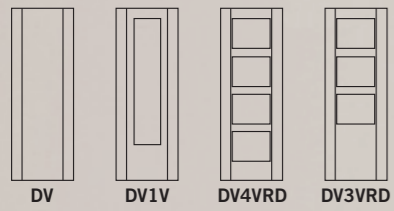

- **DV** sapelly dibujo / crown sapelly greca haya blanca / white beech inlay



- **D2C3V** roble elaborado / oak  
greca haya blanca / white beech inlay

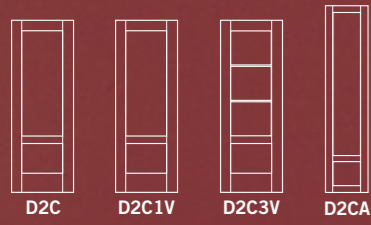

- **D2C** roble elaborado / oak  
greca haya blanca / white beech inlay

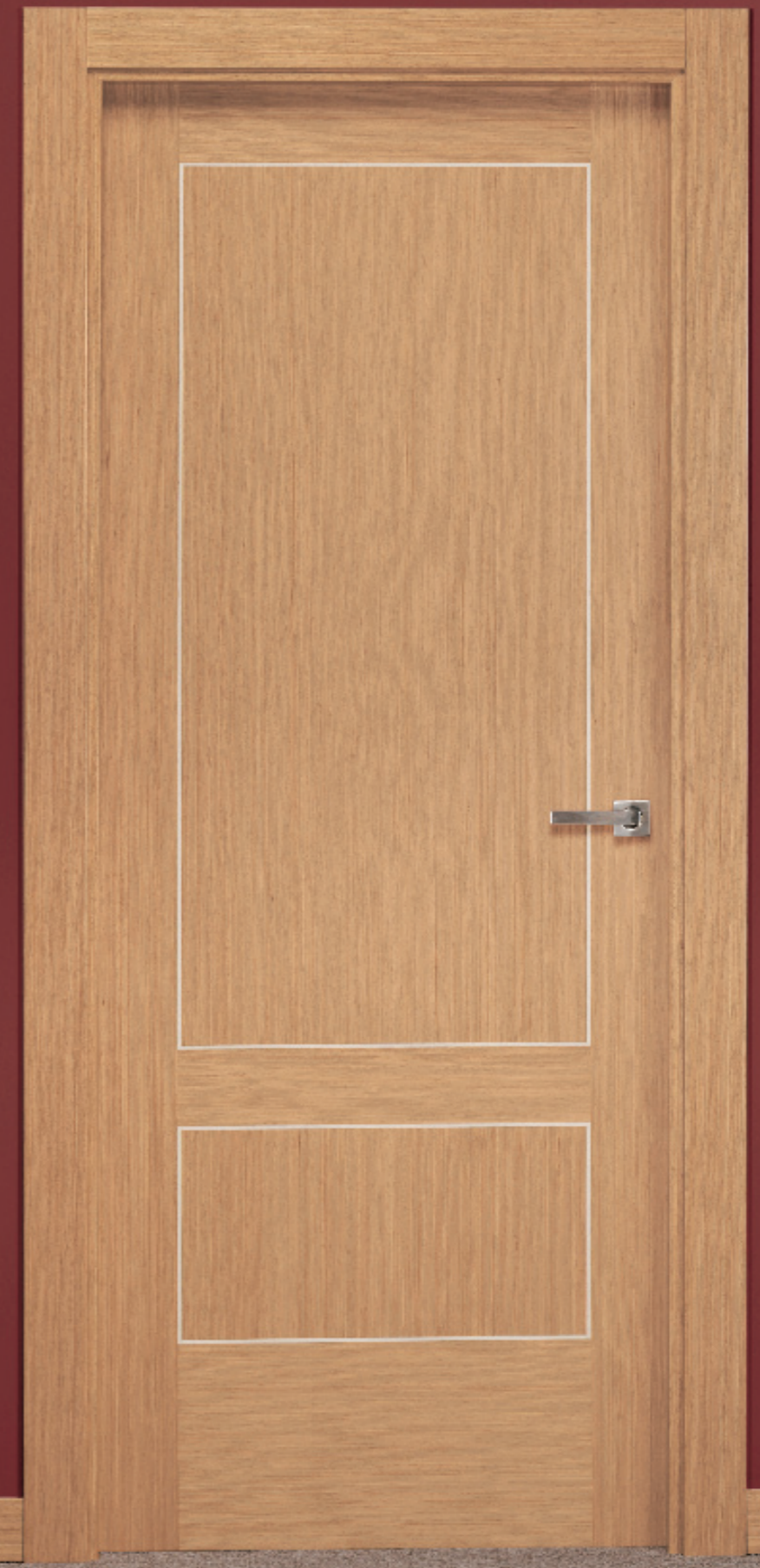

- **DD3V** etimoe / etimoe  
greca combinada / combined inlay

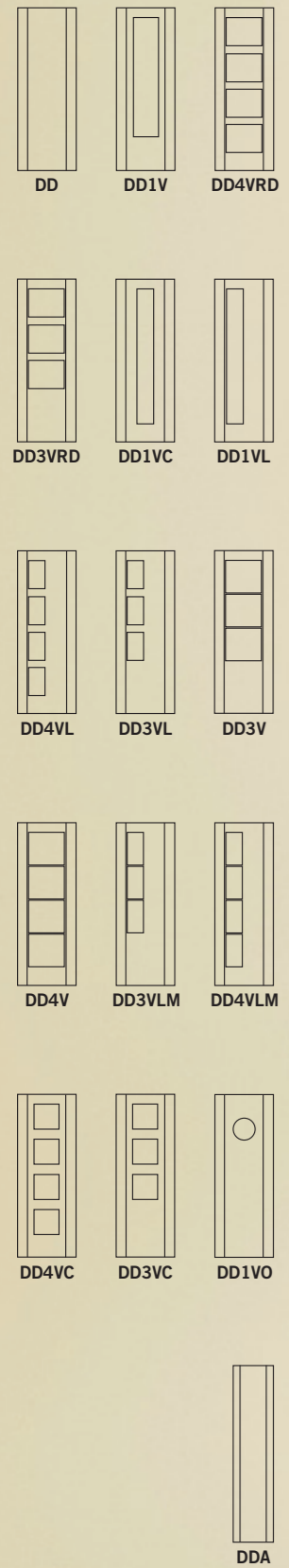

- **DD** etimoe / etimoe  
greca combinada / combined inlay





- **DXR** nogal / *walnut*  
greca haya blanca / *white beech inlay*

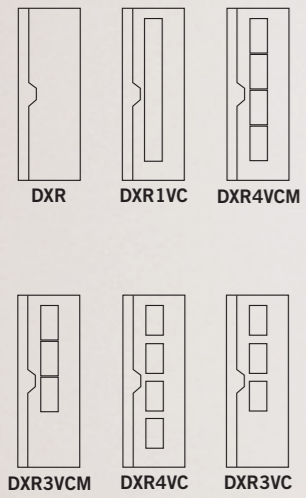

- **DCB** cebrano / *zebrawood*  
greca haya blanca / *white beech inlay*



- **DCB3VRD** cebrano / *zebrawood*  
greca haya blanca / *white beech inlay*

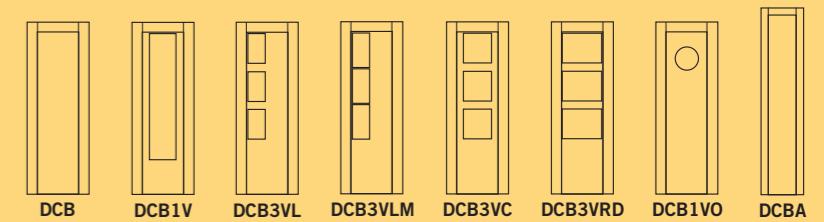

# serie NATURA

La serie NATURA presenta la puerta lisa en estado puro. Realizada con materiales de primerísima calidad, representa la sencillez y la elegancia.

*NATURA Collection presents flat door in its pure style. Made with the highest quality materials, it stands for simplicity and elegance.*

• **NN5VC** haya vaporizada / steamed beech

- **NF1VC** wengué elaborado / wenge

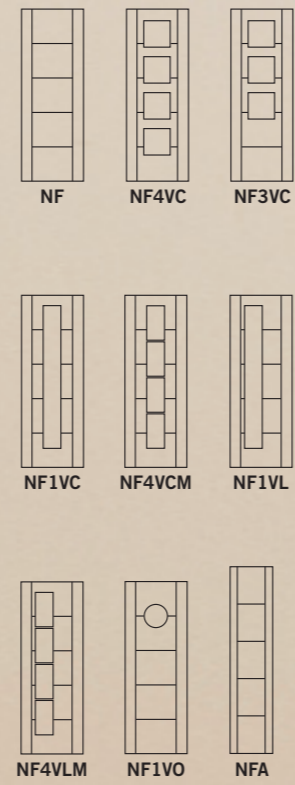

- **NF** wengué elaborado / wenge



• **NX** cedro / cedar



• **NX4VL** cedro / cedar

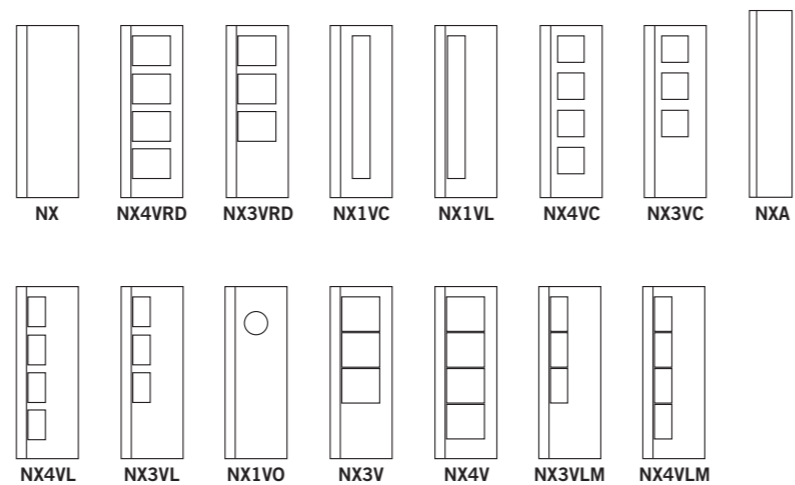

• **ND** cerezo / cherry



• **ND4VL** cerezo / cherry

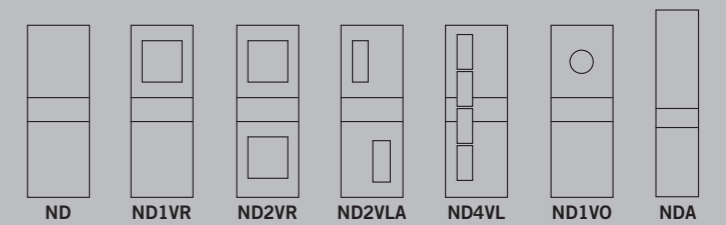
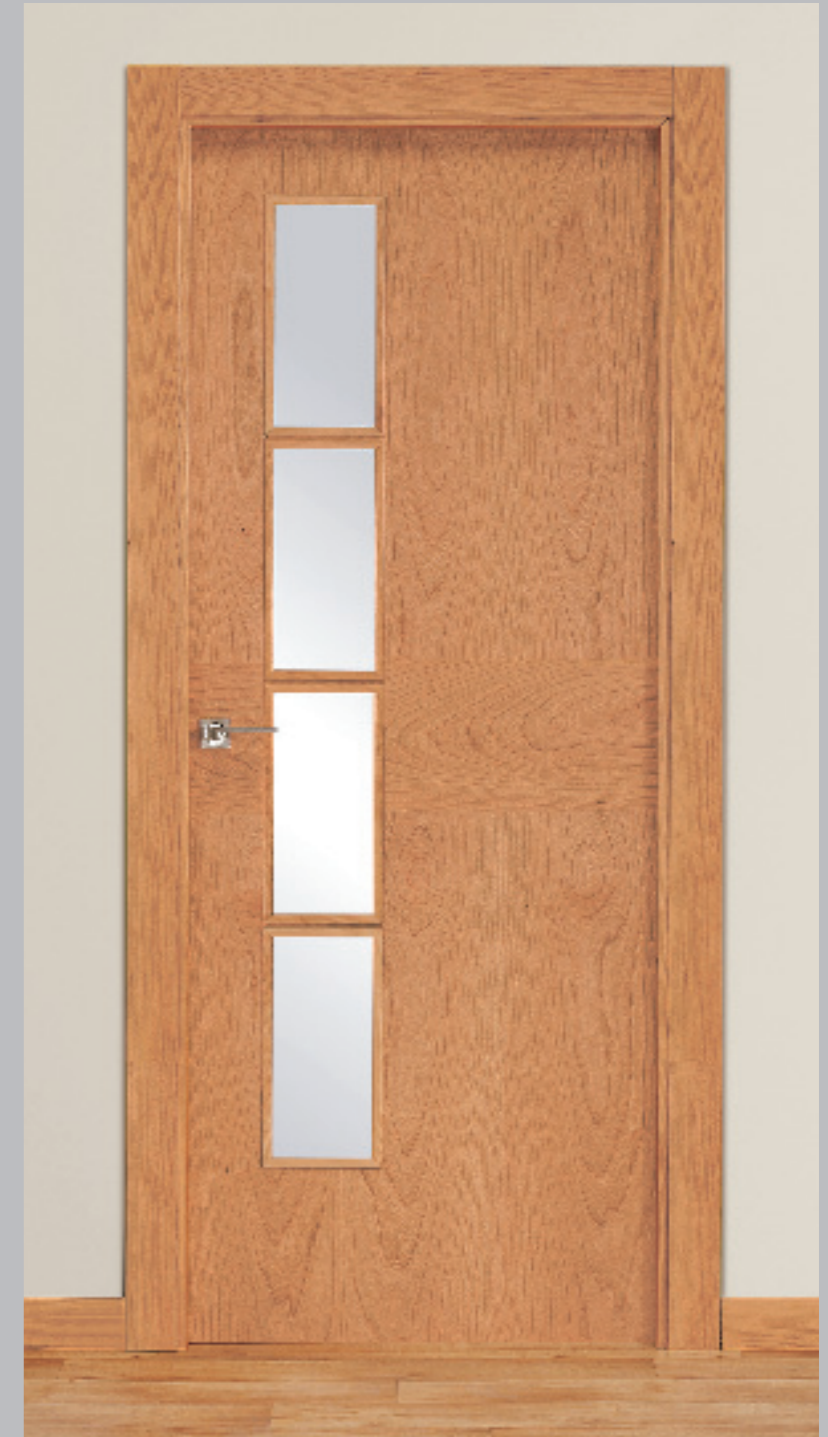

• **NN4VC** nogal / walnut

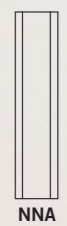
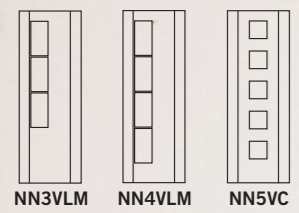
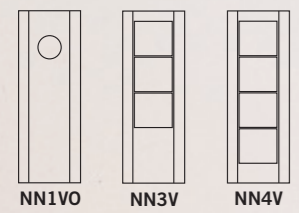
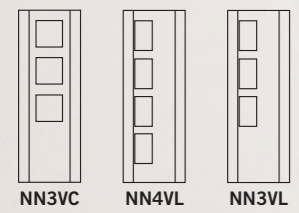
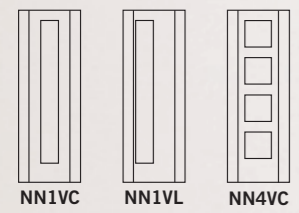
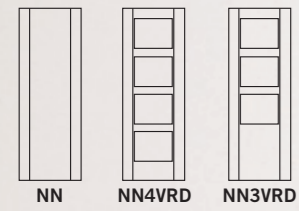

• **NN** nogal / walnut



• **NV** haya vaporizada / *steamed beech*

• **NV1V** haya vaporizada / *steamed beech*

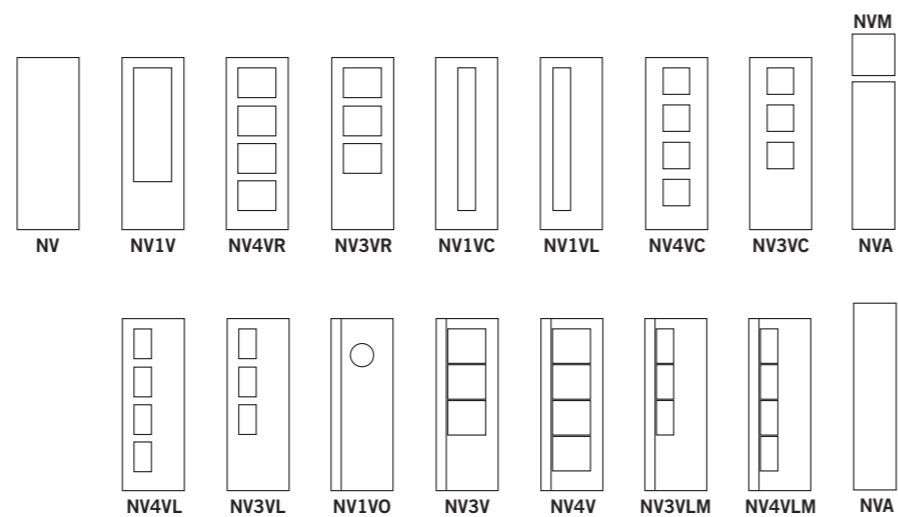

• **NH** roble / *oak*

• **NH3VR** roble / *oak*

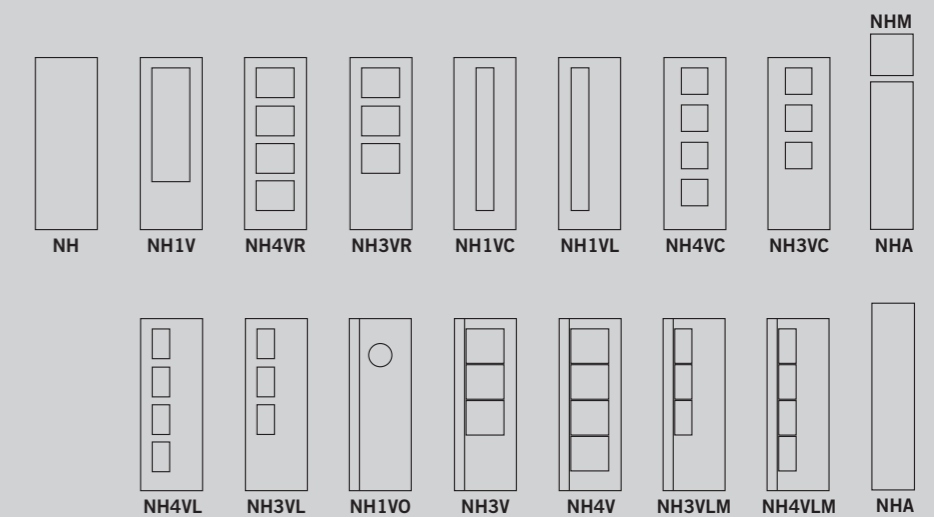

serie **PRELACADA**

• V4H prelac / prelac

• **4C** prelac / prelac



• **2C** prelac / prelac



• **2C6V** prelac / prelac



• **4C4V** prelac / prelac



• **VNA** prelac / prelac

• **VNA1V** prelac / prelac

• **V4H3VR** prelac / prelac





serie **MELAMINA**

La serie Melamina ofrece una amplia gama de acabados siguiendo las últimas tendencias en interiorismo y decoración.

*MELAMINE Collection offers a wide variety of finishes according to the latest trends.*

• DISEÑO MADERA



cedro / cedar



cerezo / cherry



teka / teka



wengué / wenge

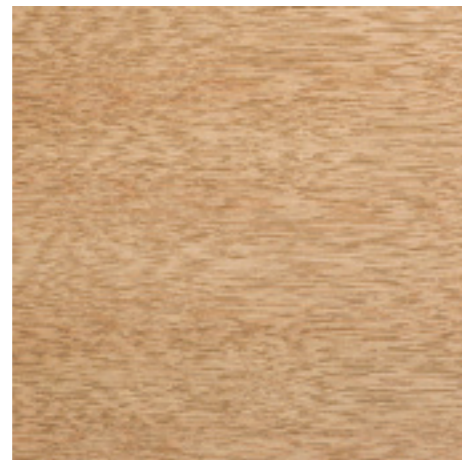

roble / oak



haya vaporizada / steamed beech

• melamina wengué horizontal 4VR  
horizontal melamine wenge 4VR



• melamina teka vertical 1V  
vertical melamine teka 1V



• melamina haya vaporizada vertical  
horizontal melamine steamed beech



• melamina wengué horizontal  
horizontal melamine wenge



• melamina cerezo horizontal  
horizontal melamine cherry



• melamina haya vaporizada horizontal  
horizontal melamine steamed beech

• DISEÑO UNICOLOR (ACABADO EN SUPERFICIE SOFT 66)



azul 15 / *blue 15*

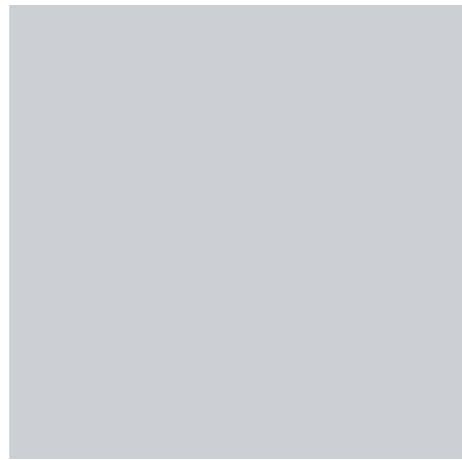

gris 41 / *grey 41*



gris 49 / *grey 49*

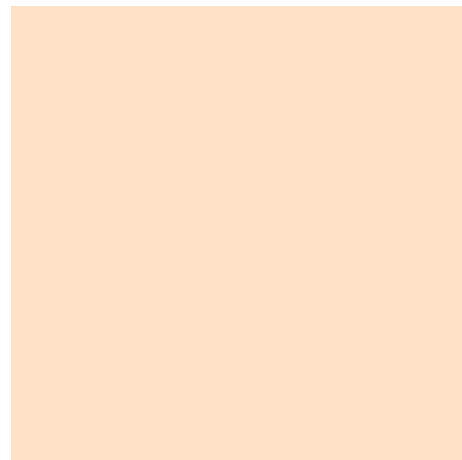

crema 31 / *cream 31*



mostaza 598 / *mustard 598*



burdeos 73 / *burdeos 73*

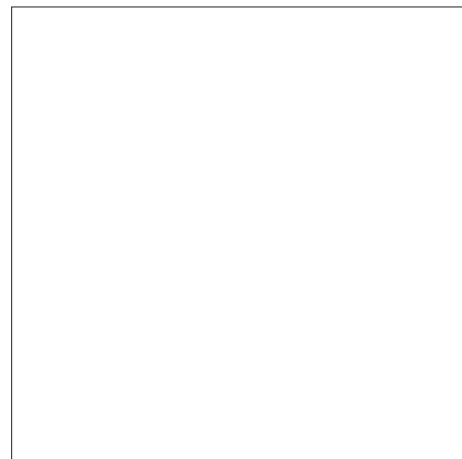

blanco 10 / *white 10*



verde 376 / *green 376*

• DETALLE PUERTA RECERCADA

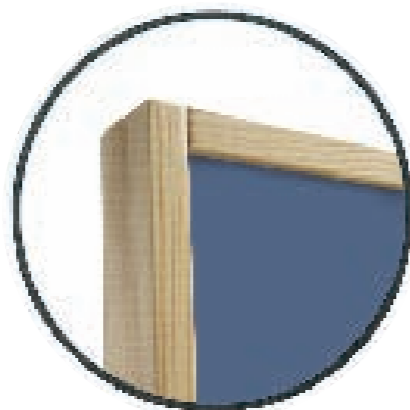

• lisa melamina azul 15 /  
*15 blue melamine*

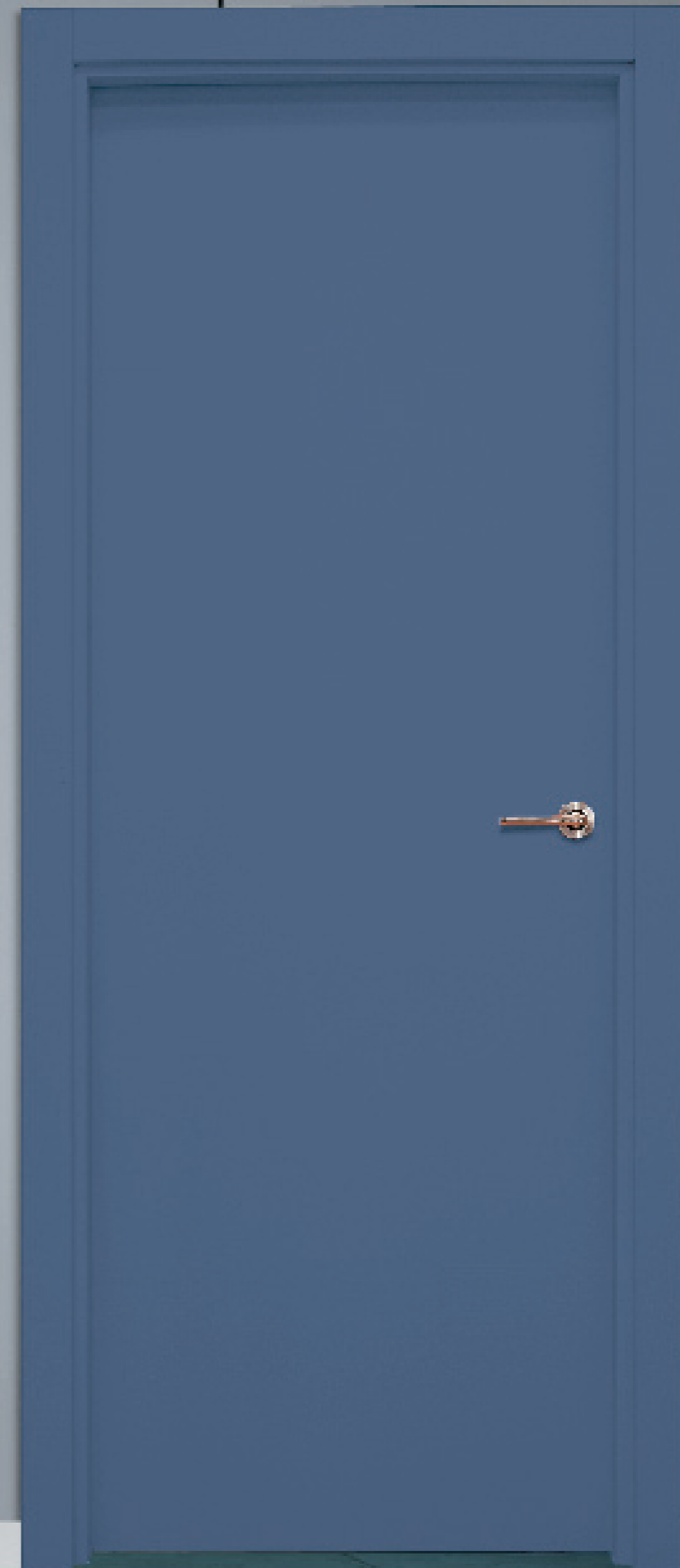

# ARMARIOS





- abatible melamina cerezo  
*folding cherry melamine*



- corredera melamina haya vaporizada perfilera plata  
*sliding door melamine steamed beech silver finish profile*



# CASONETO METÁLICO PARA PUERTAS CORREDERAS

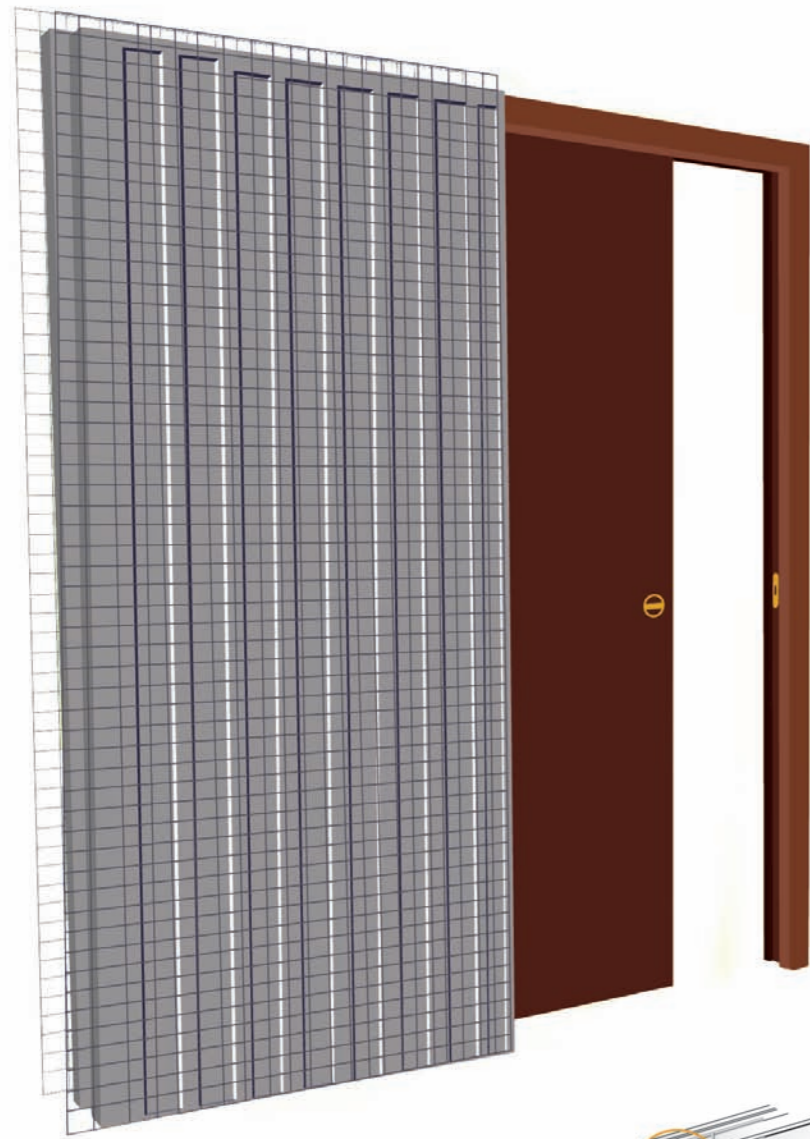

- Tiene una única hoja corredera y se adapta a las habitaciones pequeñas y grandes. La luz de paso varía de 60 cm. a 120 cm. y, por esto, es la solución ideal para todas las exigencias de espacio.

- Disponible en hoja doble.

- Todos los elementos se ensamblan con facilidad y rapidez componiendo la estructura metálica.

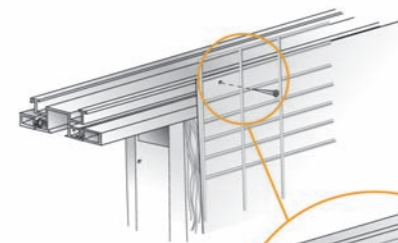
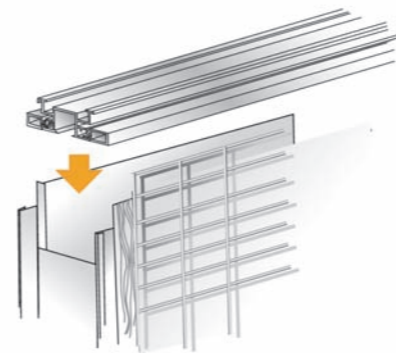

- Con los tornillos, incluidos en todos los modelos, se fija definitivamente en todas sus partes y en pavimento existente o no.

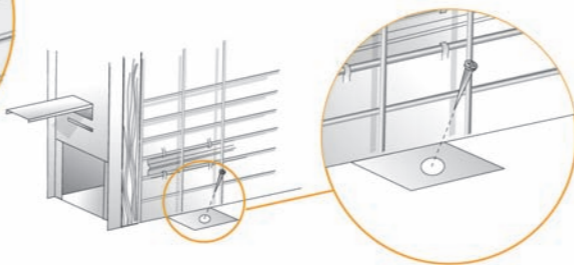
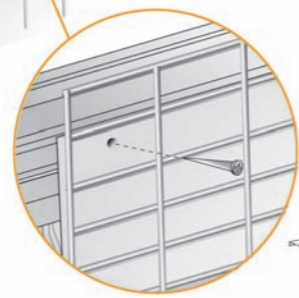

- La red desbordante constituye la solución a cada problema que pudiera manifestarse durante el estucado de las paredes. En esta fase la red que se prolonga hasta la pared hace que el revoque se amalgame rápidamente y de manera compacta evitando hendiduras. La red desbordante consentirá obtener una pared perfecta, sin ningún signo de unión con la estructura metálica.

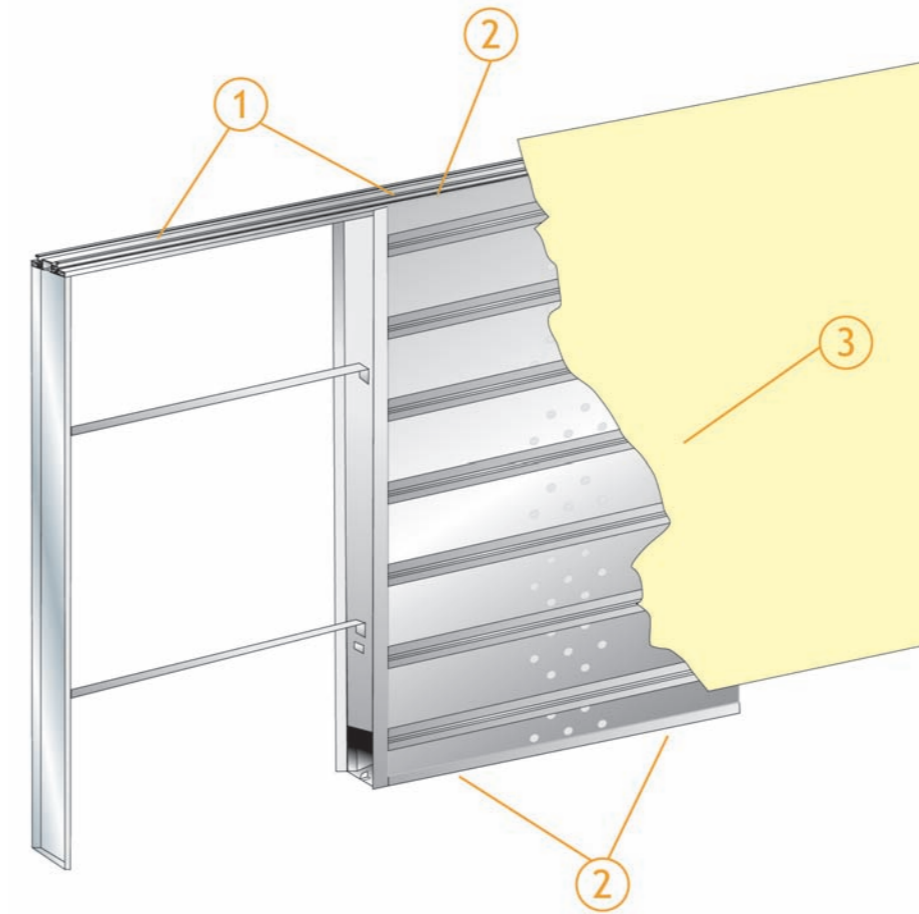
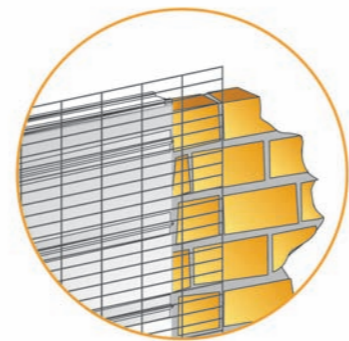

- También para la instalación en paredes de cartoneso tenemos el sistema de montaje rápido y eficaz. Los mecanismos de encaje son la solución ideal para un montaje rápido. Gracias a todos los puntos de anclaje se aplica con gran facilidad.

- Todos los elementos se ensamblan con movimientos de presión y de arrastre muy simples componiendo así la estructura metálica.

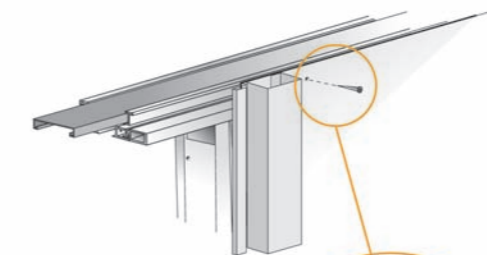
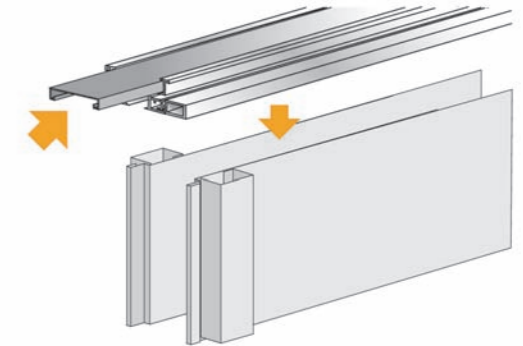

- Con los tornillos, incluidos en todos los modelos, se fija definitivamente en todas sus partes y en pavimento existente o no.

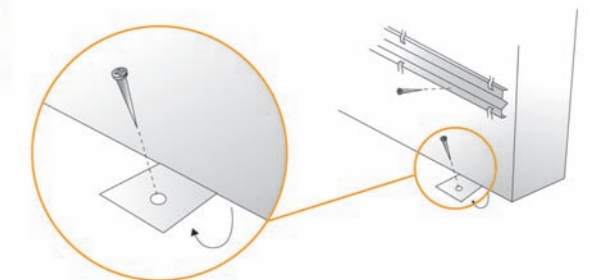

- Siempre con el auxilio de tornillos el cartoneso se fija componiendo la pared.

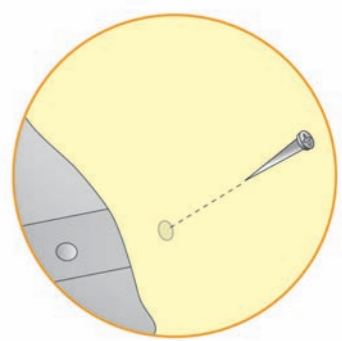

# PUERTAS ACORAZADAS

## CARACTERÍSTICAS TÉCNICAS

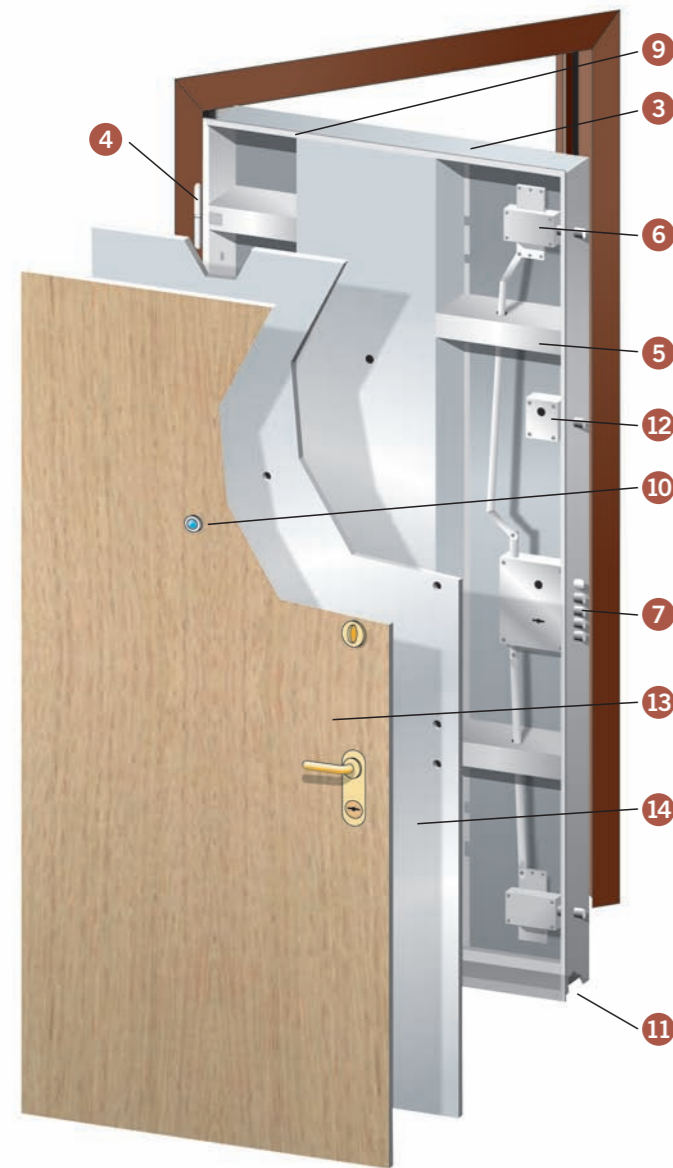

### • DOTACIÓN ESTÁNDAR

- 1 **Premarco** para la pared construido en chapa electrocincada de 20/10. Dotado con distancias para una colocación fácil y precisa.
- 2 **Marco fijo** construido en chapa de acero revestido de pvc marrón para fijar al premarco mediante placas de acero y 8 tornillos hexagonales que permiten regularlo tanto en horizontal como en vertical.
- 3 **Hoja de la puerta** construida con chapa de acero zincado preparada al interior y al exterior para aplicar cualquier tipo de revestimiento.
- 4 **Bisagras** de acero de altísima resistencia realizadas con un único perfil para fundirse en una sola estructura imposible de separar. Tienen pernio y esfera de acero inox y permiten regular la colocación de la puerta en todas las direcciones.
- 5 **Omega** de refuerzo vertical y 4 omegas horizontales, aplicados en la hoja de la puerta, en chapa de acero, convirtiendo la estructura más rígida y resistente.
- 6 **Pivote** superior e inferior.
- 7 **Cerradura** de altísima seguridad en diferentes versiones.
- 8 **Pomo fijo y picaporte en aluminio a elegir:** bronceado, cromo o dorado.
- 9 **Burlete** perimétrico para evitar la entrada de aire, polvo y ruido.
- 10 **Mirilla o visor** de la puerta con una panorámica de 180°.
- 11 **Cortavientos** automático en aluminio y goma, para adaptarse perfectamente al suelo.
- 12 **Gancho de seguridad:** limita la apertura permitiendo la apertura parcial de la puerta.

### • DOTACIÓN OPCIONAL

- 13 **Paneles de revestimiento.**
- 14 **Plancha de metal interna de acero zincado** garantizando una mejor resistencia a la intrusión.
- 15 **Aislador** interior con paneles aislantes e ignífugos para un perfecto aislamiento termo-acústico.

### • DOTACIÓN A ELEGIR

- **Pomo y picaporte en aluminio** bronceado, cromo o dorado.



• Cortavientos automático, cerrada la puerta entra en contacto con el suelo evitando la entrada de aire, polvo y luz.



• Bulones de acero de altísima resistencia. En fase de cierre bloquea la puerta a la estructura metálica formando un único cuerpo.



• Bisagras de acero fabricadas con acero de altísima resistencia. Aplicadas en la puerta se convierten en un único cuerpo inseparable, regulables en todas las direcciones.



• Gancho de seguridad, se aplica a la estructura y con una simple maniobra se acciona garantizando gran resistencia a la apertura parcial de la puerta.

### • EXCLUSIVO MARCO FIJO ANTIRROBO

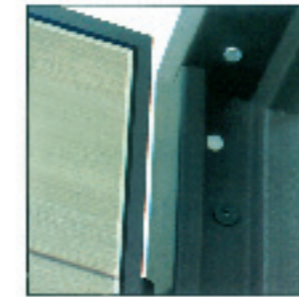

• Marco en chapa de acero revestido de material antigrafió (PVC vinilo) en diferentes acabados.

• Revestido de varios colores



Gris



Haya



Blanco 9010



Verde Mix

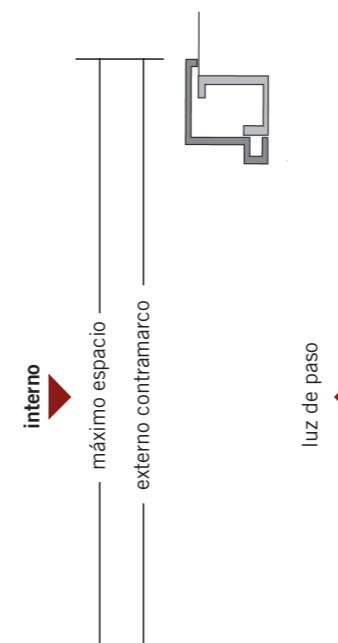

**Pomo y manilla**  
Aluminio  
bronce

**Pomo y manilla**  
Aluminio  
cromado

**Pomo y manilla**  
Aluminio  
dorado

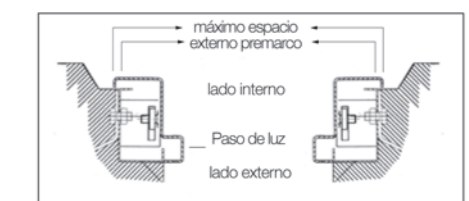
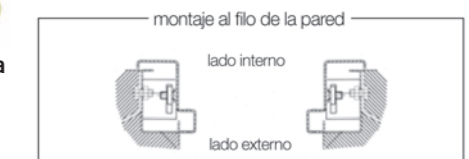

Detalle de las bisagras regulables con elegantes tapones

#### Tabla medidas

medida normal	paso de luz	externo premarco	máximo
800x2000	788x2000	922x2063	949x2078

No disponibles en otras medidas.

### • MODELO 20

Componentes específicos: cerradura con doble vuelta de llave, núcleo intercambiable y tres llaves precintadas más una de servicio.



ajuste de cierre

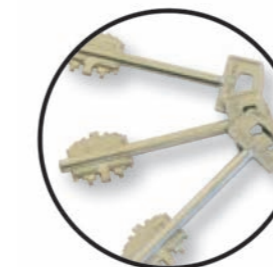

llaves



detalle núcleo



cerradura con núcleo intercambiable

### • MODELO 30

Componentes específicos: cerradura de cilindro con cinco llaves precintadas más una de servicio.



antiganzúa

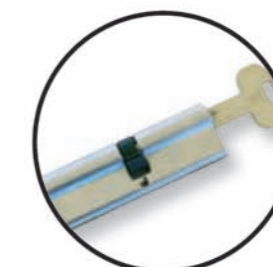

cilindro de seguridad



llaves



cerradura de cilindro

# CARACTERÍSTICAS TÉCNICAS

## • MEDIDAS ESTÁNDAR

Dimensiones (mm)	Familia						
	Blindada	Puerta de entrada	Puerta de paso	Armario	Armario cazoleta	Armario corredera	Carpelino
Altura	2030 / 2110			1800 / 2200			2030 / 2110
Anchura	825	425 / 625 / 725 / 825		400 / 450 / 500 / 550 / 600			825
Grosor	45	35		30	19	16	5/10*

\* grosor para la serie viva

## • FAMILIA

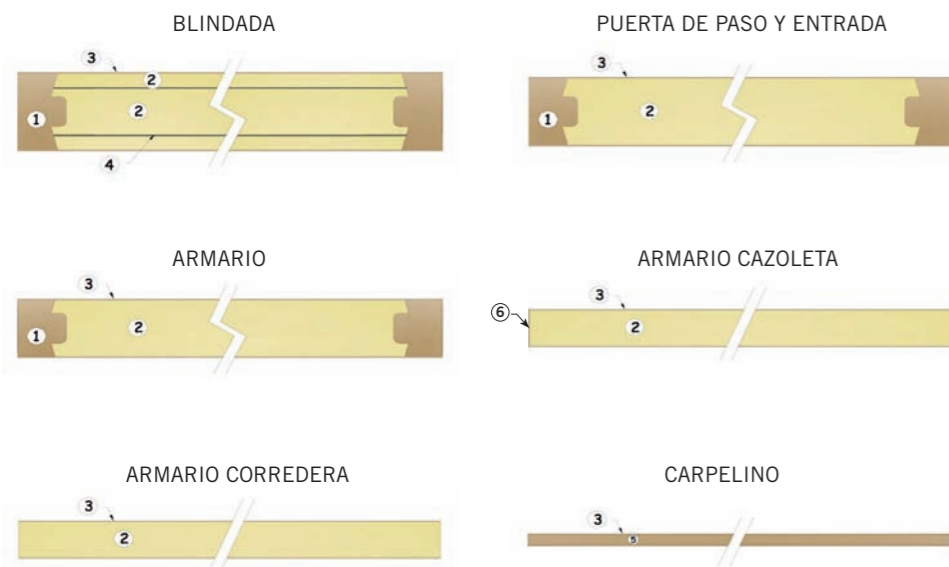

## • MATERIALES

- 1 Canto de madera maciza 22 mm.
- 2 Tablero de partículas de media densidad.
- 3 Chapa de madera maciza de 0,6 mm.
- 4 Chapa de acero galvanizado de 0,6 mm.
- 5 Tablero de fibras.
- 6 Canto de PVC de 0,6 mm.

## • TIPOS ESTRUCTURALES

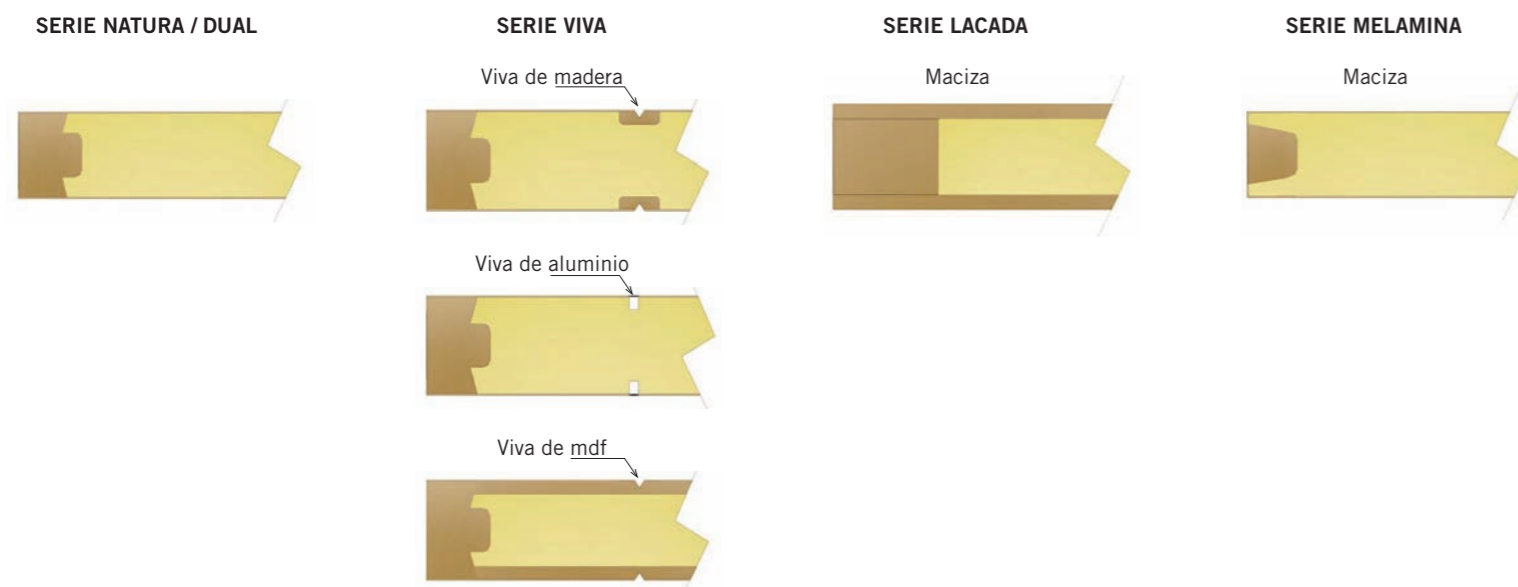

## • LUCES DE PREMARCO

Tipo y dimensión de hoja	Altura de premarco		
	Cerco de 30	Cerco de 30/15*	Cerco de 22
Puerta	Altura de hoja +30	Altura de hoja +25	Altura de hoja +20
2030	2060	2055**	2050
2110	2140	2135**	2130
Armario	Altura de hoja +50		Altura de hoja +30
1800	1850		1830
2200	2250		2230

\* Profundidad del galce  
\*\* Solo puertas de entrada

Tipo y dimensión de hoja	Ancho de premarco		
	Cerco de 30/10*	Cerco de 30/15*	Cerco de 22/10*
Puerta y armario	Ancho de hoja +50	Ancho de hoja +40	Ancho de hoja +30
625	675		655
725	775		755
825	875	865**	855
400 + 400	850		830
500 + 500	1050		1030
600 + 600	1250		1230

\* Profundidad del galce  
\*\* Solo puertas de entrada

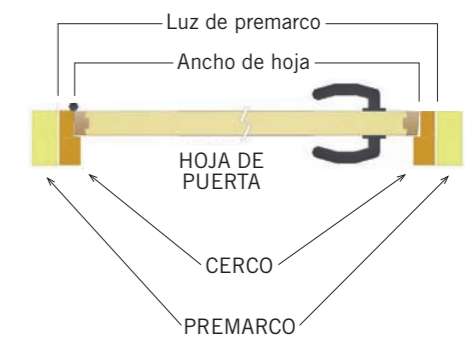
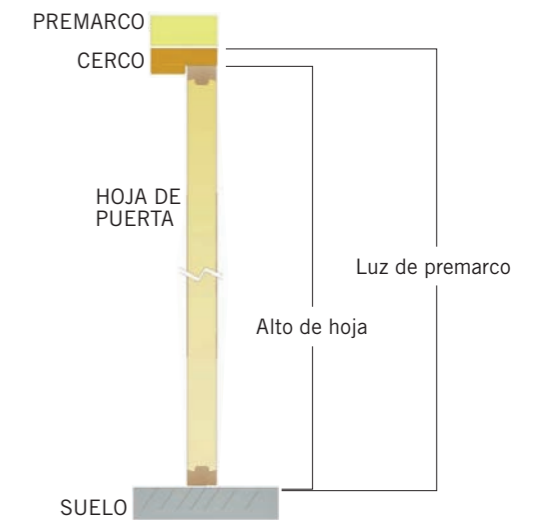



# MADERAS DISPONIBLES



wengué / *wenge*



nogal / *walnut*



sapelly / *sapelly*



sapelly dibujo / *crown sapelly*



cedro / *cedar*



cerezo / *cherry*



etimoe / *etimoe*



iroko / *iroco*



roble / *oak*



haya vaporizada / *steamed beech*



mukali / *mukaly*



maple / *maple*



ébano / *ebony*



cebrano / *zebrawood*



roble elaborado / *oak*



roble blanco / *white oak*